

Jerald Saunders
Landscape Architect
MO License # LA-007

Consultants:

FREDERIC ROOFING

2827 S. BRENTWOOD BLVD
ST LOUIS, MISSOURI 63144

Revisions:

Date	Description	No.

Drawn: LWH
Checked: JAS

LOOMIS ASSOCIATES
landscape architects + planners
750 spint 40 park drive, chesterfield, missouri 63005
t. 636-519-8668 www.loomis-associates.com

Loomis Associates Inc.
Missouri State Certificate of Authority # LAC#0000191

Sheet Title: Landscape Plan

Sheet No: L1.0

Date: 02/24/21
Job #: 813.089

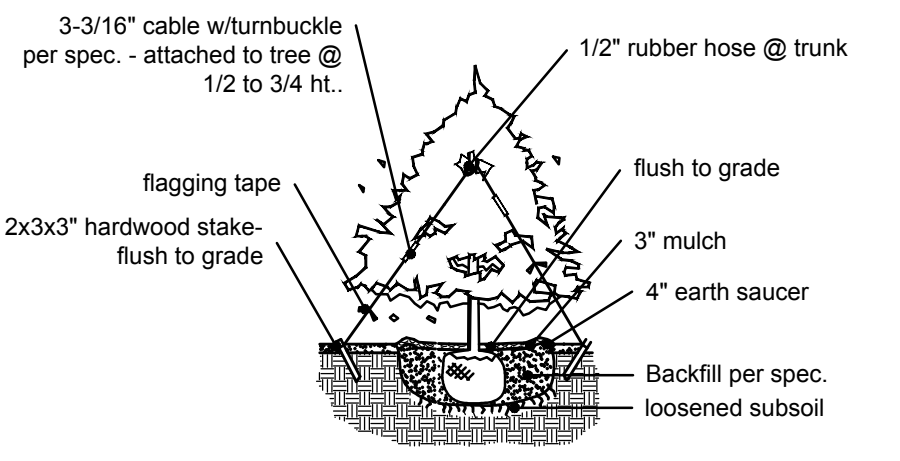
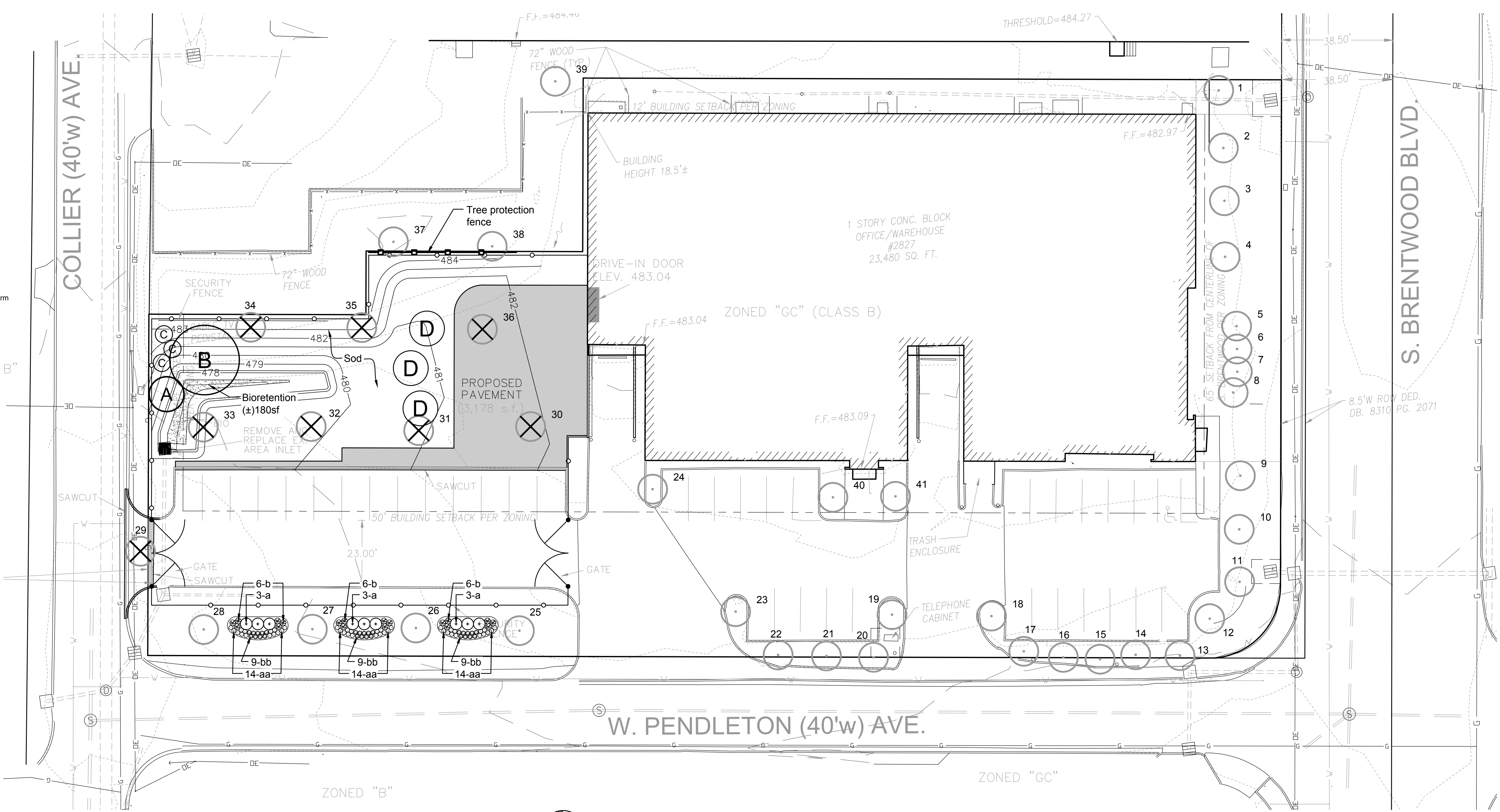

TYPICAL EVERGREEN PLANTING

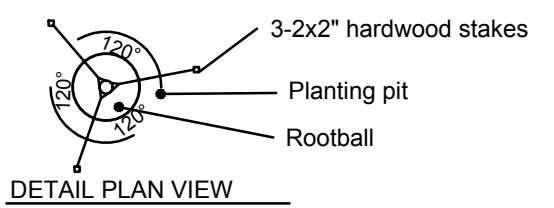

DETAIL PLAN VIEW

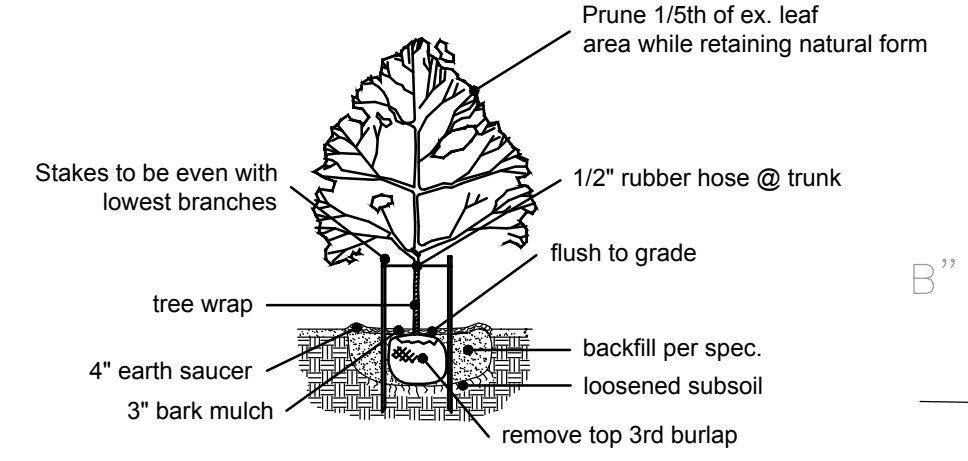

CANOPY TREE PLANTING

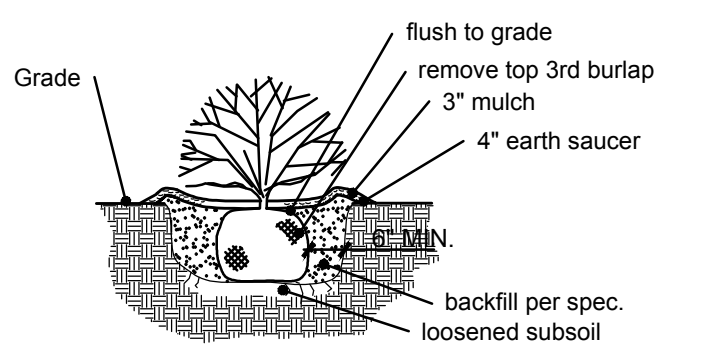

TYPICAL SHRUB PLANTING

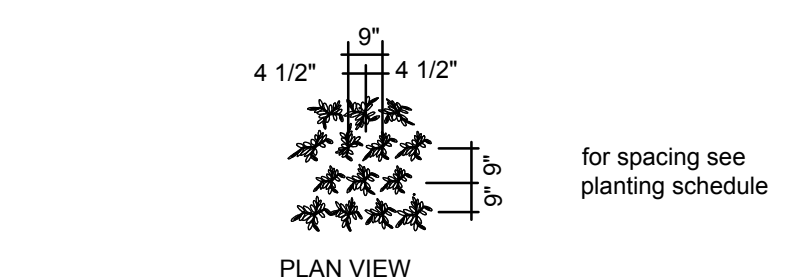

PERENNIAL/ANNUALS

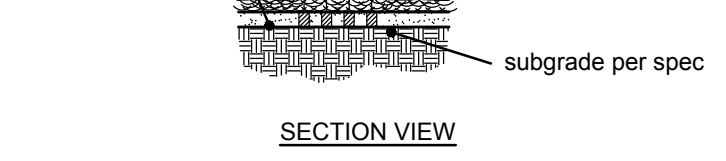

TYPICAL PERENNIAL PLANTING

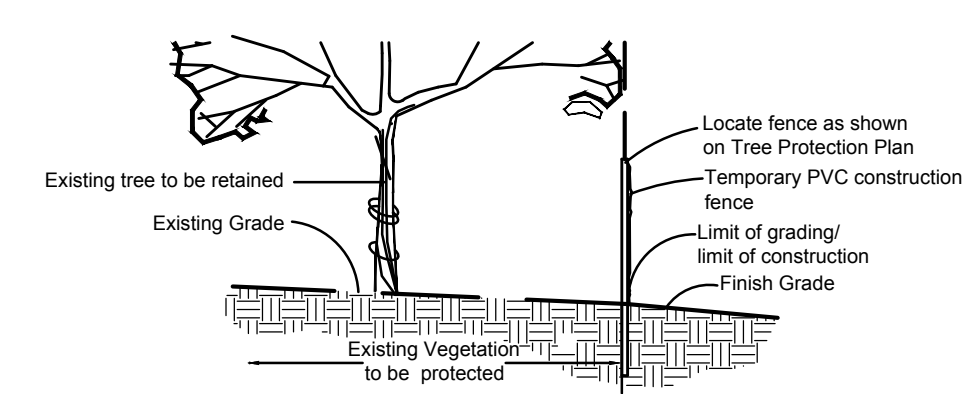

TREE PROTECTION DETAIL

ID	Tree Name	DBH / Height	Preserved	To Be Removed	Comment
1	Maple	12"	X		
2	Crabapple	8"	X		
3	Crabapple	8"	X		
4	Crabapple	6"	X		
5	Crabapple	6"	X		
6	Crabapple	6"	X		
7	Crabapple	6"	X		
8	Crabapple	8"	X		
9	Crabapple	9"	X		
10	Crabapple	9"	X		
11	Crabapple	9"	X		
12	Maple	12"	X		
13	Holly	8'	X		
14	Holly	8'	X		
15	Holly	10'	X		
16	Holly	10'	X		
17	Holly	8'	X		
18	Japanese Tree Lilac	5"	X		
19	Japanese Tree Lilac	4"	X		
20	Japanese Tree Lilac	4"	X		
21	Japanese Tree Lilac	3"	X		
22	Japanese Tree Lilac	3"	X		
23	Japanese Tree Lilac	4"	X		
24	Crabapple	4"	X		
25	Maple	4"	X		
26	Maple	3"	X		
27	Maple	2"	X		
28	Maple	5"	X		
29	Crabapple	3"		X	
30	Maple	4"		X	
31	Maple	3"		X	
32	Maple	2"		X	
33	Maple	4"		X	
34	Maple	4"		X	
35	Maple	4"		X	
36	Maple	4"		X	
37	Maple	4"	X		Offsite
38	Maple	4"	X		Offsite
39	Oak	3"	X		Offsite
40	Crabapple	4"	X		
41	Crabapple	4"	X		



- TREE PROTECTION NOTES:**
- PRE-CONSTRUCTION MEETING TO BE HELD ON-SITE TO INCLUDE A PRESENTATION OF TREE PROTECTION MEASURES TO OPERATORS, CONSTRUCTION SUPERVISORS, DEVELOPER'S REPRESENTATIVE, AND CITY ZONING INSPECTOR.
 - CLEARING LIMITS TO BE ROUGH STAKED IN ORDER TO FACILITATE LOCATION FOR INSTALLATION OF PROTECTION FENCING. NO EARLY MAINTENANCE SCHEDULE IS REQUIRED.
 - NO CLEARING OR GRADING SHALL BEGIN IN AREAS WHERE THE TREATMENT AND PRESERVATION MEASURES HAVE NOT BEEN COMPLETED, INCLUDING THE INSTALLATION OF TREE PROTECTION FENCING AS SHOWN ON THE PLAN, WHERE NECESSARY. CONTRACTOR MAY PERFORM MINOR TREE CLEARING PRIOR TO INSTALLING SILT FENCING AND TREE PROTECTION FENCING PROVIDED THEY MAINTAIN TREE PROTECTION AREA.
 - TREE PROTECTION FENCING SHALL BE 4-FOOT HIGH TEMPORARY PLASTIC CONSTRUCTION FENCE. NO EQUIPMENT TRAFFIC/PARKING, CONCRETE WASHOUT, MATERIAL STORAGE OR OTHER SUCH CONSTRUCTION ACTIVITY SHALL BE PERMITTED TO PENETRATE THE PROTECTION FENCING OR DISRUPT THE PROTECTED TREE AREA EXCEPT FOR THE REMOVAL OF DEAD OR INVASIVE PLANT MATERIAL. ALL GROUND PLANE IN PLANTING AREAS SHALL BE MULCHED WITH HARDWOOD BARK MULCH. TREE PROTECTION SIGNAGE WILL BE PLACED ALONG THE PROTECTION FENCING AS SHOWN AS THE DASHED LINE ON THE PLAN.
 - TREE PROTECTION MEASURES TO BE MAINTAINED THROUGHOUT CONSTRUCTION SEQUENCE.

- LANDSCAPE NOTES:**
- MULCH TO BE DOUBLE GROUND BARK MULCH.
 - ALL DISTURBED LAWN AREAS TO BE TURF-TYPE TALL FESCUE.
 - TOPSOIL IN ALL DISTURBED LAWN AREAS AT 6" DEPTH.
 - SOIL MIX IN ALL SHRUB BEDS AT 8" DEPTH.
 - BED EDGES TO BE SPADE CUT.
 - ADAPT EXISTING IRRIGATION SYSTEM TO PROVIDE COVERAGE FOR NEW PLANTINGS AND LAWNS.

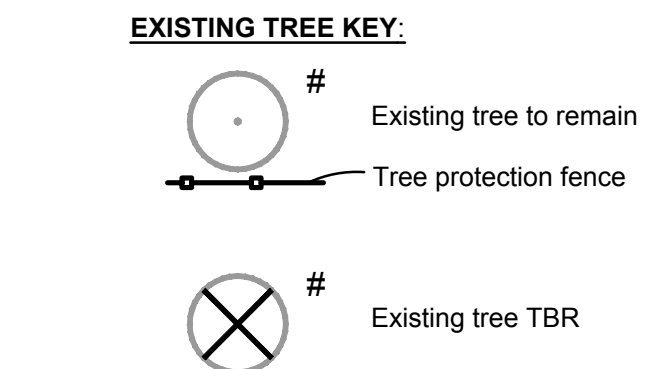

PLANTING SCHEDULE					
TREES					
SYMBOL	QUANTITY	BOTANICAL NAME	COMMON NAME	SIZE	REMARKS
A	1	Acer rubrum 'Armstrong'	Armstrong Maple	3"cal	B&B
B	1	Quercus bicolor	Swamp White Oak	3"cal	B&B
C	3	Juniperus virginiana 'Canaertii'	Canaertii Juniper	6'h	B&B
D	3	Picea pungens	Colorado Blue Spruce	6'h	B&B
SHRUBS AND LARGE GRASSES					
a	9	Viburnum dentatum 'Christom'	Blue Muffin Viburnum	24"	Cont.
b	18	Panicum virgatum 'Shenandoah'	Shenandoah Switchgrass	3 gal.	Cont.
PERENNIALS					
aa	42	Rudbeckia fulgida var. sullivantii 'Goldsturm'	Goldsturm Black-eyed Susan	1 gal	18" o.c.
bb	27	Salvia nemorosa 'Caradonna'	Caradonna Salvia	1 gal	18" o.c.
180sf		Bioretention Plantings per MSD Requirements		1 qt	varies